

# SO5100TB3



Category	75 cm
Product Family	Oven
Power supply	Electric
Heat source	ELECTRICITY
Cooking method	Thermo-ventilated
Cleaning system	Vapor Clean
EAN code	8017709327125



## Aesthetics

Aesthetic	Linea	Door	Full glass
Colour	Black	Handle	Linea minimal
Design	Flat	Handle Colour	Black
Material	Glass	Logo	Silk screen
Glass Type	Clear	Control knobs	Linea
Serigraphy colour	Grey	Controls colour	Matt black
Serigraphy type	Symbols		







## Controls



Display name	DigiScreen	Control setting	Knobs & touch buttons
Display technology	LED	No. of controls	2

## Programs / Functions main oven

No. of cooking functions 8  
Traditional cooking functions

 Static	 Fan assisted	 Circulaire
 Turbo	 Eco	 Large grill
 Fan grill (large)	 Base	

## Other functions

 Defrost by time

## Cleaning functions

 Vapor Clean

## Options

Time-setting options	Delay start and automatic end cooking	Timer	1
Minute minder	Yes		

## Technical Features



Capacity (Lt)	72 l	Circular heating element - Power	2000 W
Cavity	QS-Galileo	Heating suspended when door is opened	Yes
Minimum Temperature	30 °C	Door opening type	Standard opening
Maximum temperature	260 °C	Door	Temperate door
No. of shelves	4	Removable door	Yes
N. of fans	1	Full glass inner door	Yes
No. of lights	1	Removable inner door	Yes
Light type	Halogen	Total no. of door glasses	3
User-replaceable light	Yes	Cooling system	Tangential
Light Power	40 W	Cooling duct	Double
Light when door is opened	Yes	Speed Reduction Cooling System	Yes
Lower heating element power	1600 W	Usable cavity space dimensions (HxWxD)	312x613x402 mm
Upper heating element - Power	1200 W	Temperature control	Electronic
Grill element - power	1500 W	Cavity material	Ever clean Enamel
Large grill - Power	2700 W		

## Performance / Energy Label



Energy efficiency class	A+	Energy consumption in forced air convection	2.56 MJ
Net volume of the cavity	77 l	Energy consumption per cycle in fan-forced convection	0.71 kWh
Energy consumption per cycle in conventional mode	1.24 kWh	Number of cavities	1
Energy consumption in conventional mode	4.46 MJ	Energy efficiency index	81.6 %

## Accessories included

Rack with back stop 1

Enamelled deep tray (40mm) 1

## Electrical Connection

Voltage 220-240 V  
 Plug Not present  
 Current 14 A

Nominal power 3100 W  
 Frequency (Hz) 50/60 Hz  
 Power supply cable length 150 cm

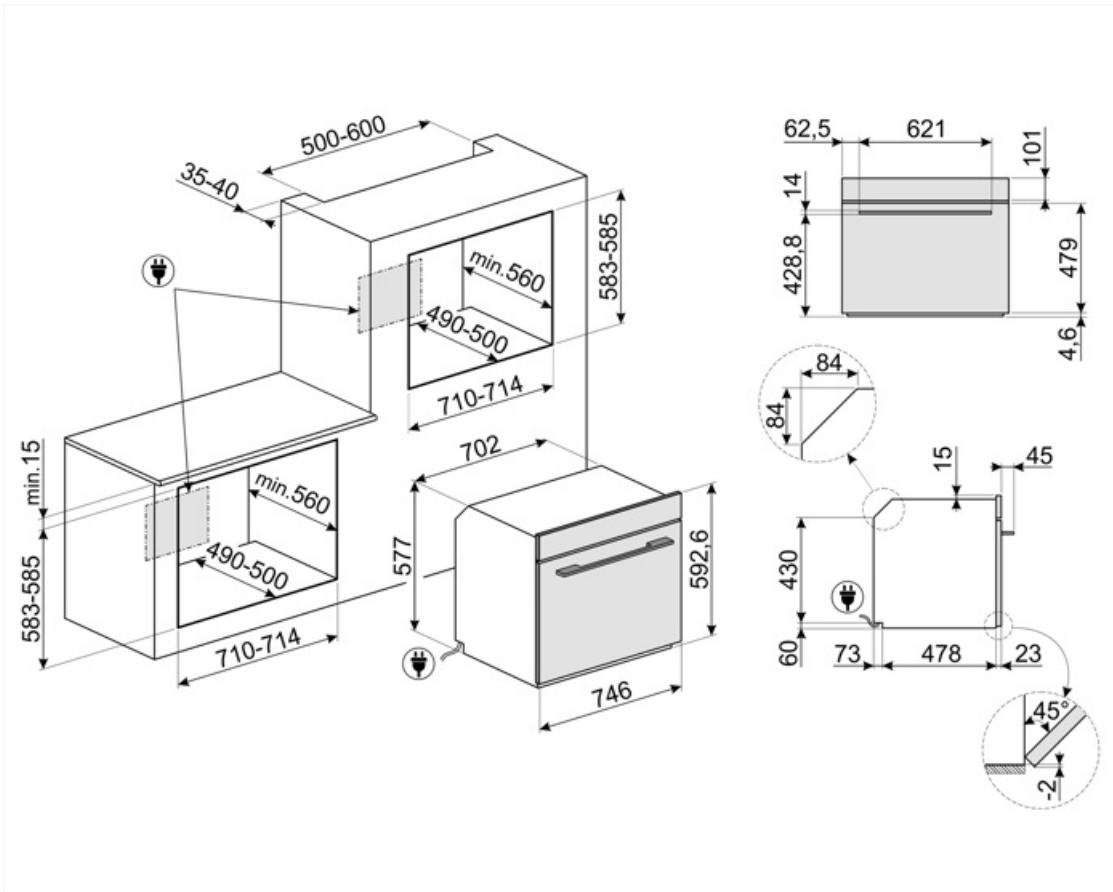

---

## Compatible Accessories

















---







### STONE

Rectangular refractory stone Ideal for cooking pizzas with the same results as a typical wood-fired oven. Can also be used for baking bread, focaccias and other recipes such as pies, flans or biscuits Dimensions:L42 x H1,8 x P37,5 cm.



## Symbols glossary

 <p><b>A+:</b> Energy efficiency class A+ helps to save up to 10% energy compared to class A. Maximum performance with minimum consumption is guaranteed.</p>	 <p><b>Air cooling system:</b> to ensure a safe surface temperatures.</p>
 <p><b>Defrost by time:</b> Manual defrost function. At the end of the set duration, the function stops.</p>	 <p><b>4.3 inch display with LED technology,</b> usability with knobs + 3 touch keys</p>
 <p><b>Triple glazed doors:</b> Number of glazed doors.</p>	 <p><b>Electric</b></p>
 <p><b>Ever Clean Enamel:</b> Ever Clean enamel is applied electrostatically, corner to corner and edge to edge to prevent cracking or cracks over time. It is a particular pyrolytic enamel, resistant to acids which, in addition to being pleasantly bright, promotes greater cleaning of the oven walls, thanks to its lower porosity. It is baked at over 850 °C and slowly polymerized at a scientifically determined rate to ensure uniform depth and strength. Ever Clean enamel creates an impeccable finish both on the inside of the oven and on the trays, making the surfaces of the oven incredibly easy to maintain over time as it reduces the adhesion of fat during cooking.</p>	 <p><b>Fan assisted:</b> Intense and homogeneous traditional cooking, also suitable for complex recipes. The fan is active and the heat comes from below and from above at the same time. Ventilated cooking ensures a faster and more homogeneous result, leaving fragrant foods outside and moister inside. Ideal for baked pasta, biscuits, roasts and cobblers.</p>
 <p><b>Static:</b> Traditional cooking suitable for the preparation of one dish at a time. The fan is not active and the heat comes from below and from above at the same time. Static cooking is slower and more delicate, ideal in order to get well cooked and dry dishes even inside. Ideal for cooking all types of roasts, fatty meats, bread, filled cakes.</p>	 <p><b>Base:</b> the heat comes only from the bottom of the cavity. The fan is not active. Ideal for sweet and savory pies, cobblers and pizzas. Designed to complete cooking and make food more crunchy. This symbol in gas ovens indicates the gas burner.</p>
 <p><b>Circulaire:</b> it is the perfect function for cooking all types of dishes in a more delicate way. The heat comes from the back of the oven and is distributed quickly and evenly. The fan is active. It is also ideal for cooking on multiple levels without mixing smells and flavors.</p>	 <p><b>ECO:</b> low energy consumption cooking: this function is particularly suitable for cooking on a single shelf with low energy consumption. It is recommended for all types of food except those that can generate a lot of moisture (for example vegetables). To achieve maximum energy savings and reduce time, it is recommended to put the food in the oven without preheating the cooking compartment.</p>
 <p><b>Grill:</b> Very intense heat coming only from above from a double heating element. The fan is not active. Provides excellent grilling and gratinating results. Used at the end of cooking, it gives a uniform browning to dishes.</p>	 <p><b>Fan grill:</b> very intense heat coming only from above from a double heating element. The fan is active. It allows the optimal grilling of thickest meats. Ideal for large cuts of meat.</p>
 <p><b>Turbo:</b> the heat comes from 3 directions: above, below and from the back of the oven. The fan is active. It allows quick cooking, even on several shelves without mixing the aromas. Ideal for large volumes or foods that require intense cooking.</p>	 <p><b>All glass inner door:</b> All glass inner door, a single flat surface which is simple to keep clean.</p>

- 
-  The inner door glass: can be removed with a few quick movements for cleaning.
  -  The oven cavity has 4 different cooking levels.
  -  Vapor Clean: a simple cleaning function using steam to loosen deposits in the oven cavity.
  -  The capacity indicates the amount of usable space in the oven cavity in litres.
  -  Side lights: Two opposing side lights increase visibility inside the oven.
  -  Electronic control: Allows you to maintain temperature inside the oven with the precision 2-3 ° C. This enables to cook meals that are very sensitive to temperature changes, such as cakes, souffles, puddings.
  -  The capacity indicates the amount of usable space in the oven cavity in litres.